

INSTRUCTION MANUAL



MULTI-FUNCTION TESTER

MODEL 6011A

KYORITSU ELECTRICAL INSTRUMENTS WORKS, LTD.

CONTENTS

| | |
|--|----|
| 1. Safe Testing | 1 |
| 2. Features | 3 |
| 3. Specification | 6 |
| 4. Continuity (resistance) tests | 10 |
| 4.1 Instrument layout | 10 |
| 4.2 Test procedure | 10 |
| 5. Insulation Tests | 12 |
| 5.1 The nature of insulation resistance | 12 |
| 5.1.2 Capacitive current | 12 |
| 5.1.3 Conduction current | 13 |
| 5.1.4 Surface leakage current | 13 |
| 5.1.5 Total leakage current | 14 |
| 5.2 Damage to voltage sensitive equipment | 14 |
| 5.3 Preparation for measurement | 15 |
| 5.4 Insulation resistance measurement | 15 |
| 6. Loop Impedance Tests | 18 |
| 6.1 Voltage measurement | 18 |
| 6.2 What is earth fault loop impedance? | 18 |
| 6.3 Automatic over temperature cut out | 18 |
| 6.4 The loop impedance test | 19 |
| 6.5 Loop impedance at 3 phase equipment | 20 |
| 7. Prospective Short Circuit Current (PSC) tests | 21 |
| 7.1 What is Prospective Short Circuit Current? | 21 |
| 7.2 Testing Prospective Short Circuit Current | 21 |
| 8. RCD Tests | 22 |
| 8.1 Purpose of RCD Test | 22 |
| 8.2 What does the RCD test really do? | 23 |
| 8.3 Uc Test | 23 |
| 8.4 Uc Testing | 23 |
| 8.5 RCD testing | 23 |
| 8.6 Testing RCD's used to provide supplementary protection | 24 |
| 8.7 Testing time delayed RCD's | 25 |
| 8.8 Testing DC sensitive RCD's | 25 |
| 9. The external earth terminal | 26 |
| 10. General | 27 |
| 11. Battery replacement | 27 |
| 12. Fuse replacement | 27 |
| 13. Servicing | 28 |
| 14. Case and Strap assembly | 29 |

1. SAFE TESTING

Electricity is dangerous and can cause injury and death. Always treat it with the greatest of respect and care. If you are not quite sure how to proceed, stop and take advice from a qualified person.

1. **This instrument must only be used by a competent and trained person and operated in strict accordance with the instructions. KYORITSU will not accept liability for any damage or injury caused by misuse or non-compliance with the instructions or with the safety procedures.**
2. **It is essential to read and to understand the safety rules contained in the instructions. They must always be observed when using the instrument.**
3. **This instrument is intended only for single phase operation at 230V AC +10%, -15% phase to earth or phase to neutral operation, and then only for loop, prospective short circuit current (PSC) and RCD testing. For use in the continuity testing and insulation testing modes this instrument **must be used ONLY on circuits which are de-energised.****
4. **When conducting tests do not touch any exposed metalwork associated with the installation. Such metalwork may become live for the duration of the test.**
5. **Never open the instrument case (except for fuse and battery replacement and in this case disconnect all leads first) because dangerous voltages are present. Only fully trained and competent electrical engineers should open the case. If a fault develops, return the instrument to your distributor for inspection and repair.**
6. **If the overheat symbol appears in the display () disconnect the instrument from the mains supply and allow to cool down.**
7. **For loop impedance tests to prevent unwanted tripping during loop testing all residual current devices (RCD's) must be taken out of the circuit and temporarily replaced with a suitably rated MCB unit. The RCD must be replaced after the loop test is completed.**
8. **If abnormal conditions of any sort are noted (such as a faulty display, unexpected readings, broken case, cracked test leads, etc) do not use the tester and return it to your distributor for repair.**
9. **For safety reasons only use accessories (test leads, probes, fuses, cases, etc) designed to be used with this instrument and recommended by KYORITSU. The use of other accessories is prohibited as they are unlikely to have the correct safety features.**
10. **When testing, always be sure to keep your fingers behind the safety**

barriers on the test leads.

11. During testing it is possible that there may be a momentary degradation of the reading due to the presence of excessive transients or discharges on the electrical system under test. Should this be observed, the test must be repeated to obtain a correct reading. If in doubt, contact your distributor.
12. The sliding shutter on the back of the instrument is a safety device. The instrument should not be used if it is damaged or impaired in any way, but returned to your distributor for attention.
13. Do not operate the function selector whilst the instrument is connected to a circuit. If, for example, the instrument has just completed a continuity test and an insulation test is to follow, disconnect the test leads from the circuit before moving the selector switch.
14. Do not rotate function dial when test button is depressed. If the function switch is inadvertently moved to a new function when the test button is depressed or in lock-down position the test in progress will be halted. To reset, release test button and press again to restart testing on new function.
15. THE WIRING CHECK LED (P-E, P-N) of this instrument is to protect the user from electrical shock resulting from incorrect connection of Line and Neutral or Line and Earth.

When the Neutral and Earth conductors are incorrectly wired, the WIRING CHECK LED function cannot identify the incorrect connection. Other procedures and test must be conducted to check and confirm that the wiring is correct prior to making measurement.

Do not use this instrument to check the correct wiring of the power supply. Kyoritsu will not be held liable for any accident that may result from incorrect wiring of the power supply line.

2. FEATURES

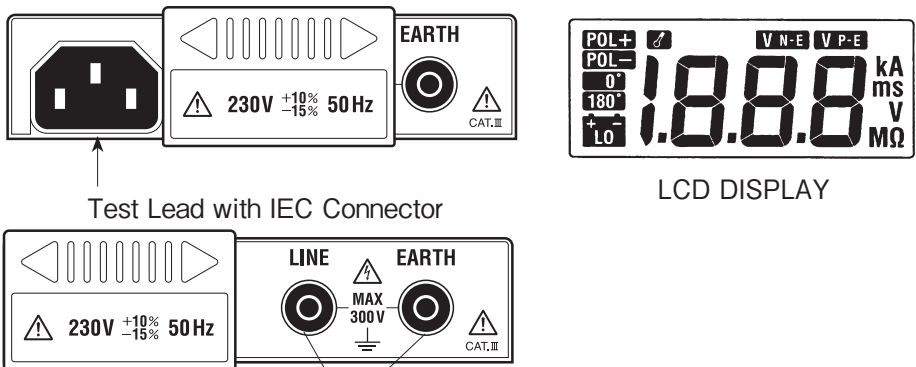
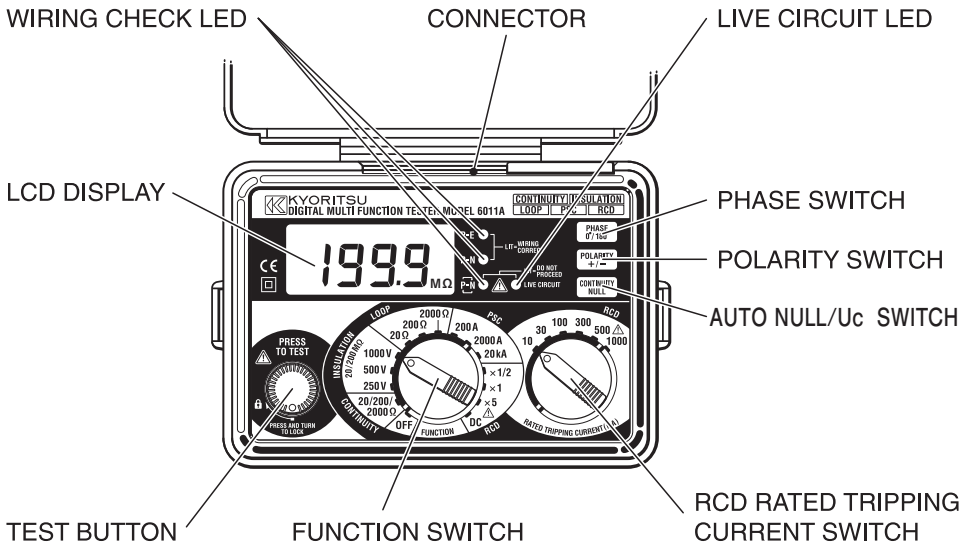

Fig. 1 Test Lead for Continuity and Insulation Testing

Model 6011A Multi-Function tester performs six functions in one instrument.

1. Continuity tester
2. Insulation resistance tester
3. Loop impedance tester
4. Prospective short circuit current tester
5. RCD tester
6. Mains voltage warning when operating the loop impedance and RCD mode.

The tester is designed to Safety Standard IEC 61010-1 CAT III (300V).

Drip-proof construction in conformance with IP54, IEC 60529.

The instrument is supplied with:-

1. A KAMP10 lead for loop/RCD testing at socket outlets.
2. Model7122B lead for insulation and continuity testing.
3. Model7132 lead for loop testing at External Earth Terminal.

In the insulation resistance testing mode the instrument provides a rated current of 1mA as required in IEC 61557-2 1997.

In the continuity testing mode the instrument provides a short circuit current of 200mA as required in IEC 61557-4 1997.

Continuity and insulation resistance functions have the following features:-

| | |
|----------------------|---|
| Live circuit warning | A colour coded LED warns if the circuit under test is live. |
| Continuity Null | Allows automatic subtraction of test lead resistance from continuity measurements. |
| Polarity switch | Allows switching of polarity during continuity tests. |
| Auto discharge | Electric charges stored in capacitive circuits are discharged automatically after testing by releasing the test button. |

Loop impedance, PSC and RCD testing functions have the following features:-
Voltage level In the loop impedance mode, supply voltage is displayed when the instrument is connected to the supply until the test button is pressed.

Wiring check Three LEDs indicate if the wiring of the circuit under test is correct.

| | |
|-----------------------------------|---|
| Over temperature protection | <p>Detects overheating of the internal resistor (used for loop and PSC tests) and of the current control MOS FET (used for RCD tests) displaying a warning symbol () and automatically halting further measurements.</p> |
| 15mA Loop measurement | <p>Loop impedance 200Ω and 2000Ω range measurement are carried out with low test current (15mA). The current will not cause tripping out involved RCD even the one with the lowest nominal differential current (30mA).</p> |
| DC Test | <p>Allows testing of RCD's which are sensitive to DC fault currents. Phase angle is positive(0°) only.</p> |
| Auto data hold | <p>Holds the displayed reading for a time after the test is complete.</p> |
| Auto power off | <p>Automatically switches the instrument off after a period of approximately 10 minutes. The power-off state returns to normal when the rotary switch is re-set to any power-on position.</p> |
| UL value change and UC Monitoring | <p>Select UL (limit of touch voltage value) 25V or 50V. In order to change it to 25V, turn the power on with pressing AUTO NULL/UC SWITCH. Then it is set to 25V can be reset to default 50V by turning the power off. Where UC (contact voltage) exceeds UL value, "UcH" will be displayed without starting the measurement.</p> |
| Optional Accessory | <p>OMA DIEC(Model 7133B) distribution board or lighting circuit and test lead for LOOP / PSC / RCD testing.</p> |

3. SPECIFICATION

Measurement Specification

| Function | Open Circuit Voltage (DC) | Short Circuit Current | Range | Accuracy |
|------------|---------------------------|-----------------------|--------------------------------|--------------------|
| Continuity | Greater than 6 V | Greater than 200mA | 20/200/2000 Ω Auto- Ranging | ± (1.5%rdg + 3dgt) |

Accuracy of this instrument will be affected on the continuity range if used in proximity of radio transmitters

| Function | Open Circuit Voltage (DC) | Rated Current | Range | Accuracy |
|-----------------------|---------------------------|---------------------------|---------------------------|--------------------|
| Insulation Resistance | 250V +40%–0% | 1mA or greater @ 250kΩ | 20/200 MΩ Auto-Ranging | ± (1.5%rdg + 3dgt) |
| | 500V +30%–0% | 1mA or greater @ 500kΩ | 20/200 MΩ Auto-Ranging | ± (1.5%rdg + 3dgt) |
| | 1000V +20%–0% | 1mA or greater @ 1MΩ | 20/200 MΩ Auto-Ranging | ± (1.5%rdg + 3dgt) |

| Function | Rated Voltage (AC) | Nominal Test Current at 0 Ω External Loop | Range | Accuracy |
|----------------|--------------------|---|--------|------------------|
| Loop Impedance | 230V+10%-15% 50Hz | 25A | 20 Ω | ± (3%rdg + 4dgt) |
| | 230V+10%-15% 50Hz | 15mA | 200 Ω | ± (3%rdg + 8dgt) |
| | 230V+10%-15% 50Hz | 15mA | 2000 Ω | ± (3%rdg + 4dgt) |

@ KAMP10 Test lead

| | | | | |
|---|----------------------|------|-------|---|
| Prospective Short Circuit Current (PSC) | 230V+10%-15% 50Hz | 15mA | 200A | PSC accuracy is a derived from measured loop impedance specification and measured voltage specification |
| | | 25A | 2000A | |
| | | 25A | 20kA | |

| Function | Rated Voltage (AC) | Trip Current | Trip Current Duration | Accuracy | |
|-----------|----------------------|---|------------------------|---|---------------------------------------|
| RCD X 1/2 | 230V+10%-15% 50Hz | 10/30/100/300/ 500/1000 mA | 2000ms | Trip Current: -10% +0% of range at 230V | Trip Time \pm (1% rdg + 3dgt) |
| RCD X 1 | 230V+10%-15% 50Hz | 10/30/100/300/ 500/1000 mA | 2000ms 1000mA@200ms | Trip Current: +10% -0% of range at 230V | |
| RCD X 5 | 230V+10%-15% 50Hz | 10 mA | 50ms | Trip Current: \pm 10 % of range at 230V | |
| | | 30/100/300mA (Note: on \times 5 range maximum current that can be generated is 1A) | | Trip Current: +10% -0% of range at 230V | |

| Function | Rated Voltage | Measuring Range | Accuracy |
|----------------------|---------------|-----------------|----------|
| Voltage Measurement- | 100-250V | 100-250V | 3% rdg |

To prevent wrong connection of test leads and to maintain safety, the dedicated terminals used for continuity and insulation tests are automatically covered when using the terminals for loop impedance, PSC and RCD tests

- Typical Number of Tests (central tendency for supply voltage up to 8V at R6)
 - Insulation Resistance Ranges : Approx. 500 times min. at load 0.5M Ω
 - Continuity Ranges : Approx. 300 times min. at load 1 Ω
 - LOOP.PSC.RCD Ranges : Operational lifetime:5h (In case of continuous duty)

Operating error

- Operating Errors (IEC 61557-2,-4)

| Function | Range | Measuring range to keep operating error | Maximum percentage operating error |
|------------|---------------|---|------------------------------------|
| Insulation | 250V | 0.25~199.9M Ω | \pm 30% |
| | 500V | 0.50~199.9M Ω | |
| | 1000V | 1.00~199.9M Ω | |
| Continuity | 20 Ω | 0.20 ~ 19.99 Ω | |
| | 200 Ω | 10.0 ~ 199.9 Ω | |
| | 2000 Ω | 100 ~ 1999 Ω | |

The influencing variations used for calculating the operating error are denoted as follows;
 Temperature: 0 °C and 35 °C
 Supply voltage : 8V to 13.8V

● Operating error of Loop Impedance(IEC61557-3)

| Range | Measuring range to keep operating error | Maximum percentage operating error |
|-------|---|------------------------------------|
| 20Ω | 0.4 ~ 19.99Ω | ± 30% |
| 200Ω | 20.0 ~ 199.9Ω | |
| 2000Ω | 200 ~ 1999Ω | |

The influencing variations used for calculating the operating error are denoted as follows:
 Temperature : 0°C and 35°C
 Phase angle : At a phase angle 0° to 180°
 System frequency : 49.5Hz to 50.5Hz
 System voltage : 230V+10%-15%

● Operating error of trip current (IEC 61557- 6)

| Function | Operating error of trip current |
|----------|---------------------------------|
| × 1/2 | -10% ~ 0% |
| × 1 | 0% ~ +10% |
| × 5 | -10% ~ +10% |



The influencing variations used for calculating the operating error are denoted as follows:
 Temperature : 0 °C and 35 °C
 Earth electrode resistance : max 20 Ω
 System frequency : 49.5Hz to 50.5Hz
 System voltage : 230V+10%- 15%

Instrument dimensions:- 130 X 183 X 100mm

Instrument weight:- 1080g including batteries.

Reference conditions Specifications are based on the following conditions except where otherwise stated:-

1. Ambient temperature: 23± 5°C
2. Relative humidity 45% to 75%
3. Position: horizontal
4. AC power source 230V, 50Hz

| | |
|---|--|
| | 5. DC power source: 12.0 V, ripple content 1% or less |
| | 6. Altitude up to 2000m |
| Battery type | Eight R6 or LR6 batteries. |
| Low battery warning | "  " symbol appears in the display and the buzzer beeps if the battery voltage drops below 8V. |
| Operating temperature and humidity. | 0 to +40°C , relative humidity 80% or less, no condensation. |
| Storage temperature and humidity | -20 to +60°C , relative humidity 75% or less, no condensation. |
| LED indication of live circuit warning | Illuminates if there is an alternating voltage of 50V AC or more in the circuit under test before continuity or insulation resistance tests. When DC voltage is detected across the measuring terminal the LED lights up. |
| LED indication of correct Polarity | The P-E and P-N LEDs illuminate when the wiring of the circuit under test is correct. The  reverse lamp is lit when P and N are reversed. |
| Auto data hold | In the loop impedance, PSC and RCD test functions, the LCD reading is automatically frozen for 5 seconds after measurement. |
| Display | The liquid crystal display has 3 1/2 digits with a decimal point and units of measurement (Ω , M Ω , A, kA, V and ms) relative to selected function. |
| Overload protection | The continuity test circuit is protected by a 0.5 A 600 V fast acting (HRC) ceramic fuse mounted in the battery compartment, where a spare fuse is also stored. The insulation resistance test circuit is protected by a resistor against 1200 V AC for 10 seconds. |
| Mains Voltage Indication | On connecting test leads to the circuit under test on Loop, PSC and RCD ranges, the LCD reads V-PE. Sign "V-PE Lo" or "V-PE Hi" is also shown when the voltage is 100V or less, or 260V or greater respectively. |

4. CONTINUITY (RESISTANCE) TESTS

⚠ WARNING
ENSURE THAT CIRCUITS TO BE TESTED ARE NOT LIVE.

DISCONNECT THE INSTRUMENT FROM THE CIRCUIT UNDER TEST BEFORE OPERATING THE FUNCTION SWITCH.

TO SELECT THE LOW RESISTANCE RANGE SELECT “CONTINUITY”

4. 1 Instrument layout See Fig 1.

4. 2 Test Procedure

The object of continuity testing is to measure only the resistance of the parts of the wiring system under test. This measurement should not include the resistance of any test leads used. The resistance of the test leads needs to be subtracted from any continuity measurement. Model 6011A is provided with a continuity null feature which allows automatic compensation for any test lead resistance.

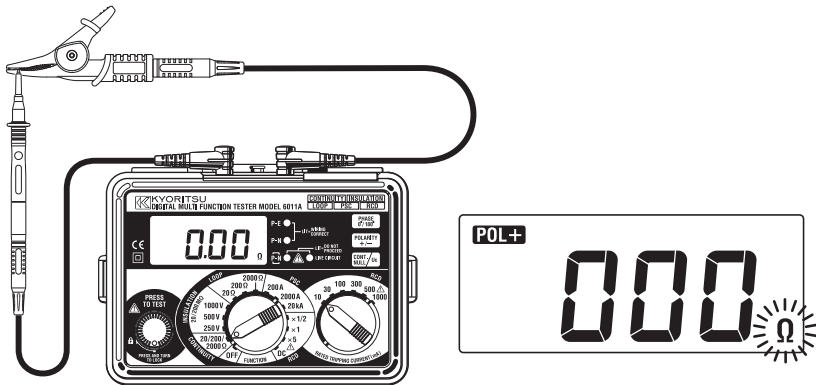

Fig 2

Proceed as follows:-

1. Select the continuity test by rotating the function dial.
2. Connect the ends of the test leads firmly together (see Fig 2) and press and lock down the test button. The value of the lead resistance will be displayed.
3. Operate the AUTO NULL/Uc SWITCH, this will null out the lead resistance and the indicated reading should go to zero.
4. Release the test button. Press the test button and ensure the display reads zero before proceeding. While using the Continuity null function, "ohm" symbol blinks. The null value will be stored even if the function switch is

turned to the OFF position. The memorized null value can be cancelled by disconnecting the test leads and pushing the AUTO NULL/Uc SWITCH with the test button pressed or locked.

CAUTION-before taking any measurements always check the leads have been zeroed.

5. Connect the test leads to the circuit whose resistance is required (see Fig 3 for a typical connection arrangement). Having first made sure **that the circuit is not live**. Note that the live circuit warning lamp will illuminate if the circuit is live - but check first anyway!
6. Press the test button and read the circuit resistance from the display. The reading will have the test lead resistance already subtracted.
7. Note that if the circuit resistance is greater than 20Ω the instrument will autorange to the 200Ω , if it is greater than 200Ω it will autorange to the 2000Ω range.

Note: If the reading is greater than 2000Ω the overrange symbol "OL" will remain displayed.

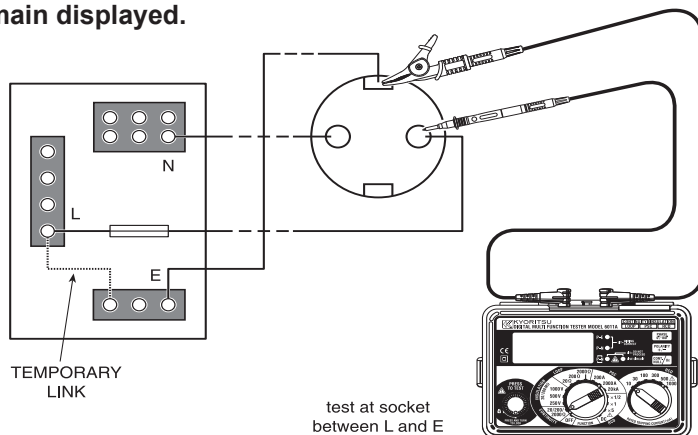

Fig 3

Model 6011A is provided with a facility to change the polarity of the test current used by the instrument during continuity tests. This can overcome affects caused by the polarisation of the installation during testing which may give inaccurate readings. To use this function proceed as follows:-

1. Perform a continuity test as outlined in the procedures above.
2. Operate the polarity switch if required.
3. Repeat the continuity tests and the polarity of the test current will be reversed.
4. A comparison can then be made between the two test results which should give the same reading.

5. INSULATION TESTS



WARNING

ENSURE THAT CIRCUITS TO BE TESTED ARE NOT LIVE.

DISCONNECT THE INSTRUMENT FROM THE CIRCUIT UNDER TEST BEFORE OPERATING THE FUNCTION SWITCH.

TO SELECT THE INSULATION RESISTANCE RANGE SELECT “INSULATION”

5. 1 The nature of insulation resistance

Live conductors are separated from each other and from earth metal by insulation, which has a resistance which is high enough to ensure that the current between conductors and to earth is kept at an acceptably low level. Ideally insulation resistance is infinite and no current should be able to flow through it. In practice, there will normally be a current between live conductors and to earth, and this is known as leakage current. This current is made up of three components, which are:-

1. capacitive current
2. conduction current, and
3. surface leakage current.

5. 1. 2 Capacitive Current

The insulation between conductors which have a potential difference between them behaves as the dielectric of a capacitor, the conductors acting as the capacitor plates. When a direct voltage is applied to the conductors, a charging current will flow to the system which will die away to zero (usually in less than a second) when the effective capacitor becomes charged. This charge must be removed from the system at the end of the test, a function which is automatically performed by Model 6011A. If an alternating voltage is applied between the conductors, the system continuously charges and discharges as the applied voltage alternates, so that there is a continuous alternating leakage current flowing to the system.

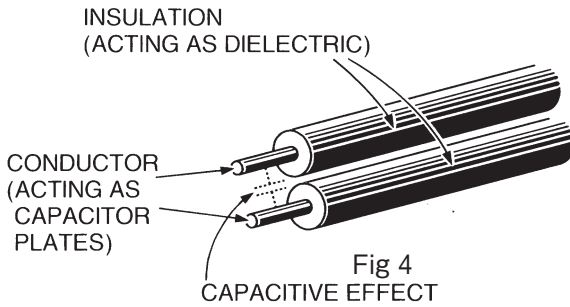

5. 1. 3 Conduction Current

Since the insulation resistance is not infinite, a small leakage current flows through the insulation between conductors. Since Ohm's Law applies, the leakage current can be calculated from

$$\text{Leakage current } (\mu A) = \frac{\text{applied voltage (V)}}{\text{insulation resistance (M}\Omega)}$$

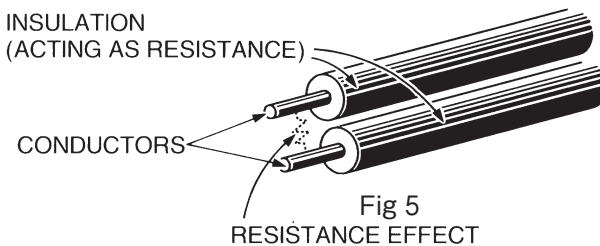

5. 1. 4 Surface Leakage Current

Where insulation is removed, for the connection of conductors and so on, current will flow across the surfaces of the insulation between the bare conductors. The amount of leakage current depends on the condition of the surfaces of the insulation between the conductors. If the surfaces are clean and dry, the value of the leakage current will be very small. Where the surfaces are wet and/or dirty, the surface leakage current may be significant. If it becomes large enough, it may constitute a flashover between the conductors.

Whether this happens depends on the condition of the insulation surfaces and on the applied voltage; this is why insulation tests are carried out at higher voltages than those normally applying to the circuit concerned.

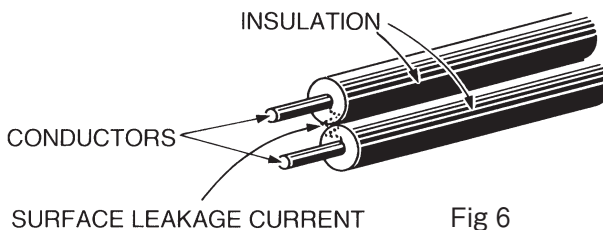

5. 1. 5 Total Leakage Current

The total leakage current is the sum of the capacitive, conduction and surface leakage current described above. Each of the currents, and hence the total leakage current, is affected by factors such as ambient temperature, conductor temperature, humidity and the applied voltage.

If the circuit has alternating voltage applied, the capacitive current (5.1.2) will always be present and can never be eliminated. This is why a direct voltage is used for insulation resistance measurement, the leakage current in this case quickly falling to zero so that it has no effect on the measurement. A high voltage is used because this will often break down poor insulation and cause flashover due to surface leakage (see 5.1.4), thus showing up potential faults which would not be present at lower levels. The insulation tester measures the applied voltage level and the leakage current through the insulation. These values are internally calculated to give the insulation resistance using the expression:-

$$\text{Insulation resistance (M}\Omega\text{)} = \frac{\text{Test voltage (V)}}{\text{Leakage current (}\mu\text{A)}}$$

As the capacitance of the system charges up, so the charging current falls to zero and a steady insulation resistance reading indicates that the capacitance of the system is fully charged. The system is charged to the full test voltage, and will be dangerous if left with this charge. Model 6011A provides an automatic path for discharging current as soon as the test button is released to ensure that the circuit under test is safely discharged.

If the wiring system is wet and/or dirty, the surface leakage component of the leakage current will be high, resulting in low insulation resistance reading. In the case of a very large electrical installation, all the individual circuit insulation resistances are effectively in parallel and the overall resistance reading will be low. The greater the number of circuits connected in parallel the lower will be the overall insulation resistance.

5. 2 Damage to Voltage-Sensitive Equipment

An increasing number of electronic-based items of equipment are being connected to electrical installations. The solid state circuits in such equipment are likely to be damaged by the application of the levels of voltage used to test insulation resistance. To prevent such damage, it is important that voltage-sensitive equipment is disconnected from the installation before the test is carried out and reconnected again immediately afterwards. The devices which may need to be disconnected before the test include:-

- Electronic fluorescent starter switches
- Passive infra-red detectors (PIRs)
- Dimmer switches
- Touch switches
- Delay timers
- Power controllers
- Emergency lighting units
- Electronic RCDs
- Computers and printers
- Electronic point-of-sale terminals (cash registers)
- Any other device which includes electronic components.

5. 3 Preparation for measurement

Before testing, always check the following:-

1. The “low battery” Indication “**Lo**” is not displayed
2. There is no visually obvious damage to the tester or to the test leads
3. Test the continuity of the test leads by switching to continuity test and shorting out the lead ends. A high reading will indicate that there is a faulty lead or that the fuse is blown.
4. **MAKE SURE THAT THE CIRCUIT TO BE TESTED IS NOT LIVE.** A warning lamp is lit if the instrument is connected to a live circuit but test the circuit as well!

5. 4 Insulation resistance measurement

Model 6011A has a selectable, triple test voltage of 250V, 500V and 1000V DC.

1. Select the insulation resistance setting by rotating the function dial to the required test voltage - 250V, 500V or 1000V as indicated under the “insulation” test section of the functional switch, after making sure that the instrument is not connected to a live circuit.
2. Attach the test leads to the instrument and to the circuit or the appliance under test (see Figs 7 & 8)

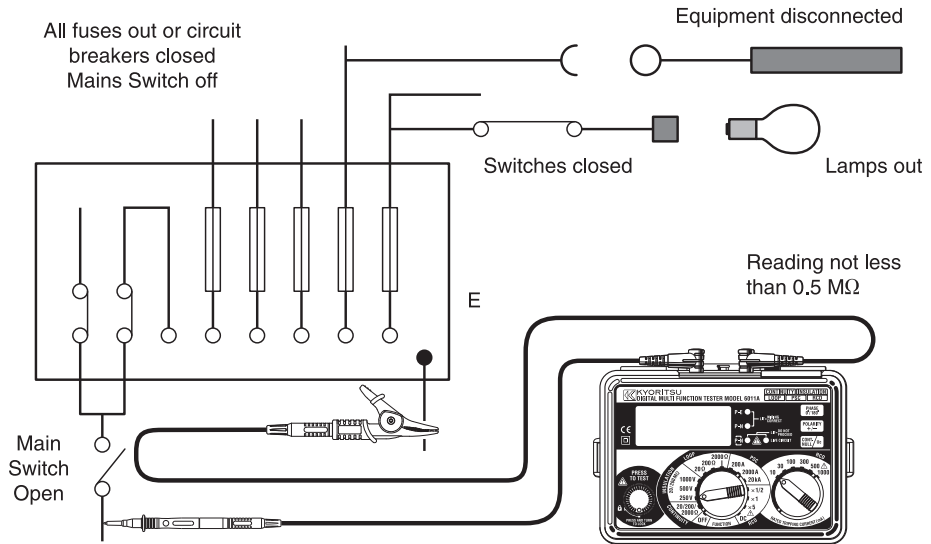

Fig 7

Note: Insulation testing must only be undertaken on de-energised circuits.

3. If the mains warning lamp lights and/or the buzzer sounds DO NOT PRESS THE TEST BUTTON but disconnect the instrument from the circuit. Make the circuit dead before proceeding.

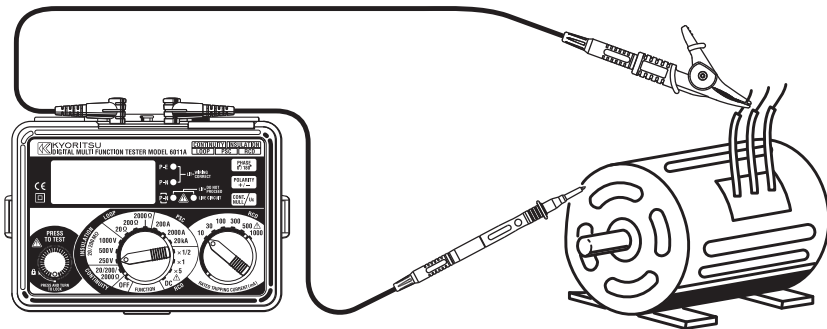

Fig 8

4. Press the test button when the display will show the insulation resistance of the circuit or the appliance to which the instrument is connected.
5. Note that if the circuit resistance is greater than 20MΩ the instrument will automatically range to the 200MΩ reading.

6. When testing is complete release the test button BEFORE disconnecting the test leads from the circuit or from the appliance. This will ensure that the charge built up by the circuit or the appliance during insulation test is dissipated in the discharge circuit. In the discharging process, an LED illuminates and the live circuit warning buzzer will sound.



CAUTION

NEVER TURN THE FUNCTION DIAL WHILE THE TEST BUTTON IS DEPRESSED AS THIS MAY DAMAGE THE INSTRUMENT. NEVER TOUCH THE CIRCUIT, TEST LEAD TIPS OR THE APPLIANCE UNDER TEST DURING INSULATION TESTING.

Note : If the reading measured greater than $200M\Omega$ the over range reading “OL” will be displayed.

6. LOOP IMPEDANCE TESTS

DISCONNECT THE INSTRUMENT FROM THE CIRCUIT UNDER TEST BEFORE OPERATING THE FUNCTION SWITCH

TO SELECT THE LOOP TESTING RANGE SELECT “LOOP”

6.1 Voltage Measurement

When the tester is set to the loop test function, mains voltage is displayed as soon as the instrument is connected for test. This voltage display is automatically updated every 1 second. The voltage function operates whenever the test button is in the up position.

6.2 What is earth fault loop impedance?

The path followed by fault current as a result of a low impedance fault occurring between the phase conductor and earth is called earth fault loop. Fault current is driven round the loop by the supply voltage, the amount of current depending on the voltage of the supply and on the impedance of the loop. The higher the impedance, the lower will be the fault current and the longer it will take for the circuit protection (fuse or circuit breaker) to operate and interrupt the fault.

To make sure that fuses will blow or that circuit breakers will operate quickly enough in the event of a fault, the loop impedance must be low, the actual maximum value depending on the characteristics of the fuse or the circuit breaker concerned. Every circuit must be tested to make sure that the actual loop impedance does not exceed that specified for the protective device concerned.

6.3 Automatic over-temperature cut-out

During the short test period the instrument dissipates power of about 6 kW. If frequent tests are conducted over a prolonged period of time, the internal test resistor will overheat. When this happens, further tests are automatically inhibited and the over-temperature symbol () appears in the display. The instrument must then be left to cool down, when testing may be resumed.

6.4 The loop impedance test



WARNING

DO NOT PROCEED WITH TESTING UNLESS THE P-E AND P-N LAMPS ARE LIT TO CONFIRM THAT THE WIRING IS CORRECTLY CONNECTED. Should these two lamps not be lit, investigate the wiring connections of the installation and rectify any faults before proceeding with the test. If the  LED is lit do not proceed.

a. Loop Impedance at Mains Socket Outlet

1. Select the 20 Ω ,200 Ω or 2000 Ω range as desired
2. Connect the mains lead to the IEC socket of the instrument(see fig9).
3. Plug the moulded plug of the mains lead into the socket to be tested
4. Carry out the initial checks
5. Press the test button. A beep will sound as the test is conducted and the value of loop impedance will be displayed
6. Wait for the display to indicate the input voltage before conducting another test or before disconnecting the instrument from the socket.
If the display shows “OL” then this usually means the value measured exceeds the range selected, e.g. if the 20 Ω range was selected then the loop impedance is greater than 19.99 Ω and you must switch up a range to the 200 Ω range.

b. Loop impedance at the distribution board

-In order to test the Loop impedance at the distribution board equipment the optional OMA DIEC(Model7133B)is necessary.

1. Select the 20 Ω ,200 Ω or 2000 Ω range as required
2. Connect the optional OMA DIEC(Model7133B)to the IEC socket on the instrument
3. Connect the red phase lead of the optional OMA DIEC(Model7133B) to 1 phase of the distribution board, the black neutral lead to the neutral of the distribution board and the green crocodile clip to the earth
4. Carry out the initial checks
5. Press the test button. A beep will sound as the test is conducted and the value of loop impedance will be displayed
6. Wait for the display to indicate the input voltage before conducting another test or disconnecting from the distribution board. When disconnecting from the distribution board, it is good practice to disconnect the phase first system.

6.5 Loop impedance at 3 phase equipment

In order to test the Loop impedance at 3 phase equipment the optional OMA DIEC(Model7133B) is necessary.

Use the same procedure as in 6.4 above ensuring that only one phase is connected at a time i.e. : First Test: red prod to phase 1, black prod to neutral, green crocodile clip to earth.

Second Test: red prod to phase 2, black prod to neutral, green crocodile clip to earth etc.

⚠ WARNING : NEVER CONNECT THE INSTRUMENT TO TWO PHASES AT THE SAME TIME.

Testing as described in 6.4 and 6.5 above will measure the Phase-Earth loop impedance. If you wish to measure the Phase-Neutral loop impedance then the same procedure should be followed except the earth clip should be connected to the neutral of the system i.e.: the same point as the black neutral probe.

If the system has no neutral then you must connect the black neutral probe to the earth i.e.: the same point as the green earth clip. This will only work if there is no RCD in this type of system.

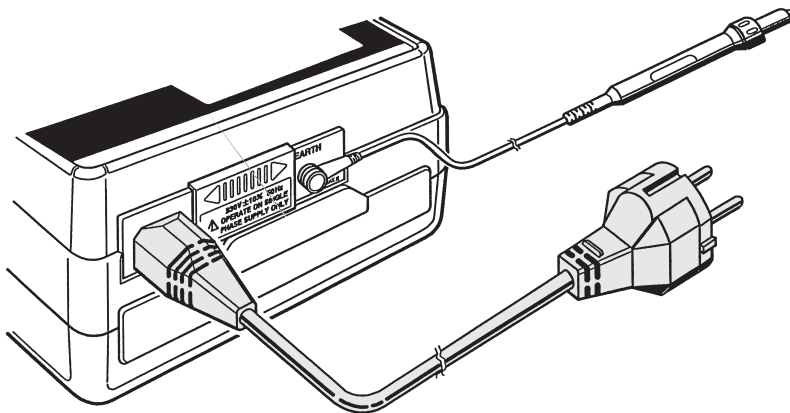

Fig 9

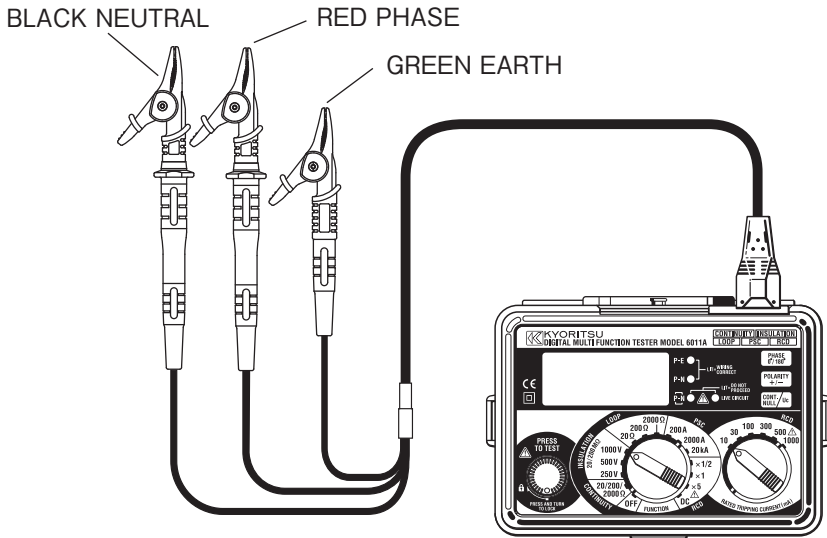

Fig 10

7. PROSPECTIVE SHORT CIRCUIT CURRENT (PSC) TESTS

⚠ WARNING
NEVER CONNECT THIS INSTRUMENT ACROSS 2 PHASES.
NEVER ATTEMPT TO MEASURE THE PHASE TO PHASE
PROSPECTIVE SHORT CIRCUIT CURRENT.

7.1 What is Prospective Short Circuit Current?

The Prospective Short Circuit or Fault Current at any point within an electrical installation is the current that would flow in the circuit if no circuit protection operated and a complete (very low impedance) short circuit occurred. The value of this fault current is determined by the supply voltage and the impedance of the path taken by the fault current. Measurement of Prospective Short Circuit Current (PSC) can be used to check that protective devices within the system will operate within safety limits and in accordance with the safe design of the installation.

7.2 Testing Prospective Short Circuit Current

PSC is normally measured at the distribution board between the phase and neutral, or at a socket outlet between phase and earth.

If testing at a distribution board proceed as follows:-

In order to test the PSC, the OMA DIEC(Model7133B) of option is necessary.

1. Select the 200A, 2000A or 20kA range.
2. Connect the OMA DIEC(Model7133B) distribution board lead to the IEC socket on the instrument.
3. Connect the red phase probe of the OMA DIEC(Model7133B) to the phase of the system, the black probe to the neutral of the system and the green crocodile clip to the neutral of the system.
4. Carry out the initial checks.
5. Press the test button. A bleep will sound as the test is conducted and the value of PSC will be displayed.
6. Wait for the display to clear to zero before conducting another test or disconnecting the instrument. It is good practice to disconnect the phase lead first.

Note : On 200A PSC range, for Loop impedance lower than 5 ohm (PSC greater than 50A approx) is not possible to obtain an accurate PSC reading even if the unit will give a result. In these cases, for accurate PSC tests, please use the 2000A or 20KA ranges.

If the PSC ranges are selected whilst connected to a socket outlet via the mains lead KAMP10, a test will take place between Phase and Earth due to fixed wiring of the moulded mains plug i.e. a **Phase-Earth fault current test**.

8. RCD TESTS

DISCONNECT THE INSTRUMENT FROM THE CIRCUIT UNDER TEST BEFORE OPERATING THE FUNCTION SWITCH TO SELECT THE RCD TEST RANGE SELECT “RCD”

8.1 Purpose of the RCD test

The RCD must be tested to ensure that operation takes place quickly enough to ensure that there is unlikely to be serious danger to a person experiencing an electric shock from the system. This test must NOT be confused with that taking place when the "test" button on the RCD is pressed; operation of the test button simply trips the breaker to ensure that it is working, but does not measure the time taken to break the circuit.

 **CAUTION : Setting up to 300mA are effective in the RCD × 5 function. In 300/500/1000mA range current value is limited to approximately 1.0A. And measuring time of the 1000mA range is limited to the 200ms .Also, setting up to 500mA is effective in the RCD DC function. In 1000mA range current is limited to approximately 500mA.**

8.2 What does the RCD test really do?

The RCD is designed to trip out when the difference between the phase current and the neutral current (this is called the residual current) reaches the tripping value (or rating) of the device. The tester provides a carefully preset value of residual current depending on its setting and then measures the time lapse between the application of the current and the operation of the RCD.

8.3 Uc Test

Ground being imperfect in the Fig11, when R exists, when fault current flows to R, electric potential occurs. There is a possibility the person contacting in this imperfect ground, it calls the voltage, which it occurs in the human body of this time, called U_c .

When with the U_c Test letting flow $I \triangleq N$ to the RCD, the U_c is calculated.

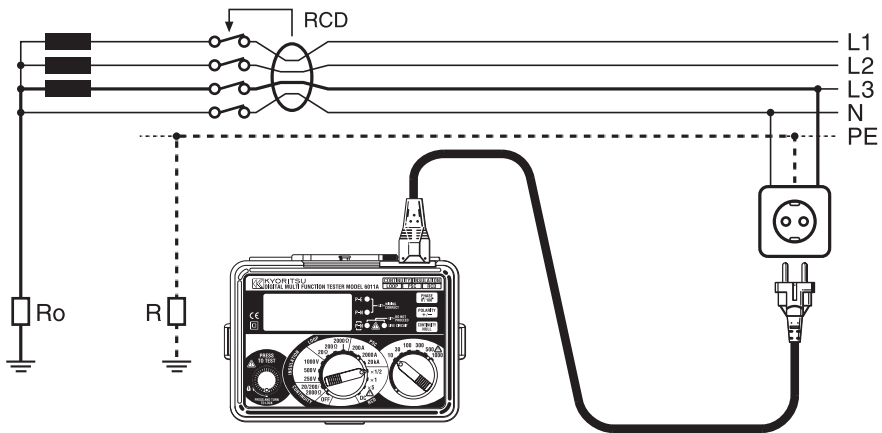

Fig 11

8.4 U_c Testing

1. Set the Function switch and select RCD.
2. Set the RCD rated tripping switch and select TEST CURRENT.
3. Make sure that " U_c " is displayed on the LCD after pressing the AUTO NULL/ U_c SWITCH.

Then, the result will be displayed by pressing the TEST BUTTON.

8.5 RCD testing

1. Set the RCD rated tripping switch to the trip rating of the RCD under test.
2. Set the function switch to X1/2 for the "no trip" test, which ensures that the RCD is operating within its specification and is not too sensitive.
3. Press the phase selector switch to indicate 0° in the display.

4. Connect the instrument to the RCD to be tested either via a suitable socket outlet (see fig 9) or using the OMA DIEC(Model7133B) test lead set (see fig 10) .
5. Make sure that the P-E and P-N wiring check lamps are lit and the wiring incorrect  LED is not lit. If they are not, disconnect the tester and check the wiring for a possible fault.
6. If the lamps are correctly lit, press the test button to apply half the rated tripping current for 2000 ms, when the RCD should **not** trip. The PN and PE LEDs should remain on indicating the RCD has not tripped.
7. Press the phase selector switch to indicate 180° in the display and repeat the test.
8. In the event of the RCD tripping, the trip time will be displayed, but the RCD maybe faulty.
9. Set the function switch to X1 for the “trip” test, which measures the time taken for the RCD to trip with the set residual current.
10. Press the phase selector switch to indicate 0° on the display.
11. Make sure that the P-E and P-N wiring check lamps are lit. If they are not, disconnect the tester and check the wiring for a possible fault.
12. If the lamps are lit, press the test button to apply full rated tripping current and the RCD should trip, the tripping time being shown on the display. If the RCD has tripped the PN and PE LEDs should be off. Check this is so.
13. Press the phase selector switch to indicate 180° in the display and repeat the test.
14. MAKE SURE TO KEEP CLEAR OF EARTHED METAL DURING THE OPERATION OF THESE TESTS.
15. The unit calculates the contact voltage with the impedance measured, and if the calculated contact voltage exceeds 50V, the unit indicates the warning on the LCD and stops the measurement. If the value is less than 50V, the unit proceeds with the measurement of a RCD.

8.6 Testing RCDs used to provide supplementary protection. (X5 TRIP TEST)

RCDs rated at 30 mA or less are sometimes used to provide extra protection against electric shock. Such RCDs require a special test procedure as follows:-

1. Set the function switch to X5 for the “fast” trip test.
2. Press the phase selector switch to indicate 0° in the display.
3. Connect the test instrument to the RCD to be tested.
4. Make sure that the P-E and P-N wiring check lamps are lit. If they are not, disconnect the tester and check the wiring for a possible fault.
5. If the lamps are lit, press the test button to apply a test current of 150mA where the RCD should trip within 40ms, the tripping time being shown on the

display.

6. Press the phase selector switch to indicate 180° in the display and repeat the test.
7. **MAKE SURE TO KEEP CLEAR OF EARTHED METAL DURING THE OPERATION OF THIS TEST.**

8.7 Testing time delayed RCDs

RCDs with a built-in time delay are used to ensure discrimination, that is, that the correct RCD operates first. Testing is carried out in accordance with item 8.3 above, except that the displayed tripping times are likely to be longer than those for a normal RCD. Since the maximum test time is longer, there may be danger if earthed metal is touched during the test.

MAKE SURE TO KEEP CLEAR OF EARTHED METAL DURING THE OPERATION OF THIS TEST.

Note : If the RCD does not trip the tester will supply the test current for a maximum of 2000ms on the X1/2 and X1 ranges. The fact that the RCD has not tripped will be evident because the PN and PE LEDs will still be on.

8.8 Testing DC sensitive RCDs

Model 6011A has a facility to test RCDs that are sensitive to DC fault currents. This test can be performed on all Test Current ranges.

Note:Phase angle is positive(0°) only.

Proceed as follows:

1. Set the RCD rated tripping current to 30mA.
2. Set the function switch to DC test position.
3. Make sure that the P-E and P-N wiring check lamps are lit. If they are not, disconnect the tester and check the wiring for a possible fault.
4. If the lamps are lit, press the test button to apply rated tripping current and the RCD should trip, the tripping time being shown on the display.

MAKE SURE TO KEEP CLEAR OF EARTHED METAL DURING THE OPERATION OF THIS TEST

9. The external earth terminal

- . The external earth terminal at the ranges of Loop, PSC and RCD, the buzzer warns that the mains earth is switched to the external earth terminal.

Connect the external earth probe firmly to a new earth point and press the test button to measure loop impedance. If the connection of the external earth probe and the terminal is normal, the move of symbols is repeated on the LCD, and finally, the measured value is displayed.

LCD Display when the external earth terminal is used.

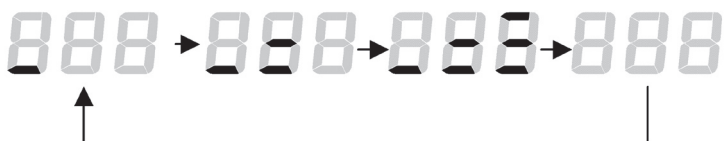

LCD Display when the IEC connector is used.

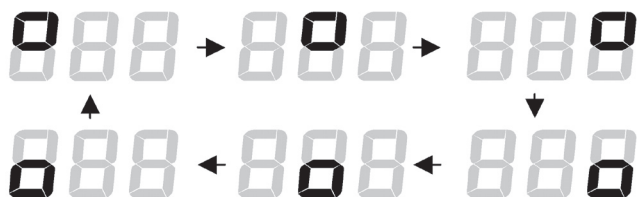

If the external earth probe is badly connected, the following symbol will be shown on the LCD and the measurement will be stopped.



10. GENERAL

The test button can be locked down for ease of use by pressing it and turning clockwise. Do not forget to release test button by turning it counterclockwise before disconnecting the instrument from the test points. Failure to do so may leave the tested circuit in a charged condition when carrying out insulation test. The instrument is provided with a sliding cover to ensure that leads for testing continuity and insulation resistance cannot be connected at the same time as test leads for loop testing and RCD testing. If this sliding cover is damaged so that it fails to perform its function, do not use the instrument and return it to your distributor for attention.

11. BATTERY REPLACEMENT

When the display shows the low battery indication, (), disconnect the test leads from the instrument. Remove the battery cover and the batteries. Replace with eight (8) new 1.5 V R6 or LR6 batteries, taking care to observe correct polarity. Replace the battery cover.

12. FUSE REPLACEMENT

The continuity test circuit is protected by a 600 V 0.5 A HRC ceramic type fuse situated in the battery compartment, together with a spare. If the instrument fails to operate in the continuity test mode, first disconnect the test leads from the instrument. Next remove the battery cover, take out the fuse and test its continuity with another continuity tester. If it has failed, replace it with a spare, before refitting the battery cover. Do not forget to obtain a new fuse and place it in the spare position.

If the instrument will not operate in the loop impedance, PSC and RCD modes, it may be that the protective fuses fitted on the printed circuit board have blown. If you suspect that the fuses have failed, return the instrument to your distributor for service - do not attempt to replace the fuses yourself.

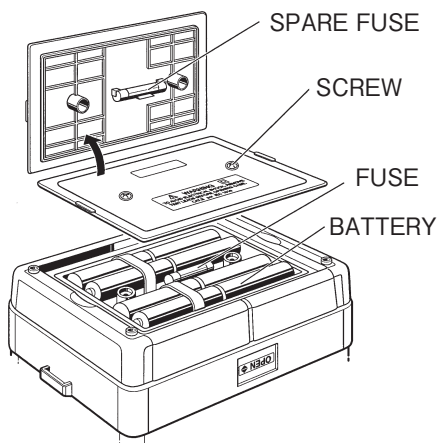

Fig 12

13. SERVICING

If this tester should fail to operate correctly, return it to your distributor stating the exact nature of the fault. Before returning the instrument ensure that:-

1. The leads have been checked for continuity and signs of damage.
2. The continuity mode fuse (situated in the battery compartment) has been checked.
3. The batteries are in good condition.

Please remember to give all the information possible concerning the nature of the fault, as this will mean that the instrument will be serviced and returned to you more quickly.

14. CASE AND STRAP ASSEMBLY

Correct assembly is shown in Fig 12. By hanging the instrument round the neck, both hands will be left free for testing.

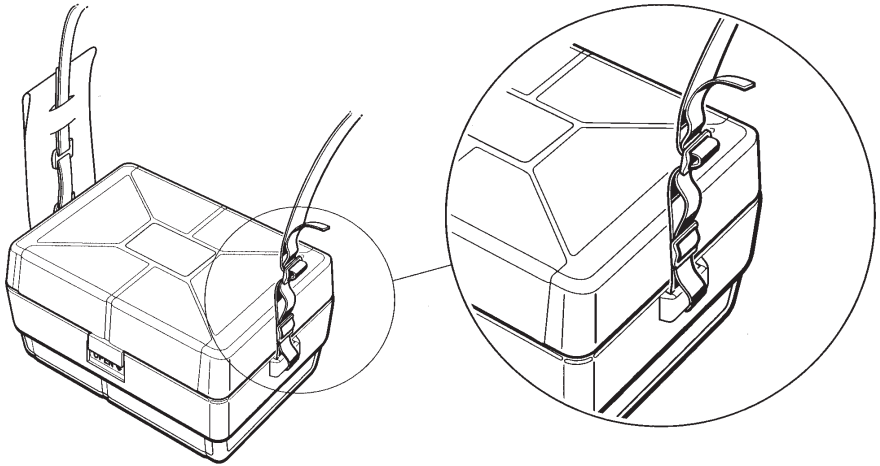

Fig13

DISTRIBUTOR

7-11

92-1530E

Kyoritsu reserves the rights to change specifications or designs described in this manual without notice and without obligations.



KYORITSU ELECTRICAL INSTRUMENTS WORKS, LTD.

No.5-20,Nakane 2-chome, Meguro-ku,
Tokyo, 152-0031 Japan

Phone: +81-3-3723-0131

Fax: +81-3-3723-0152

Factory: Ehime

www.kew-ltd.co.jp